

**Thank you for
downloading this free
activity sheet from The
Hollydog Blog.**



**Terms of Use: These materials are free for personal
and classroom use only. DO NOT sell or redistribute this
file.**

**All artwork in this download was created
by Amanda Leemis. If you have any
questions or concerns, please reach out to
amanda@thehollydogblog.com.**



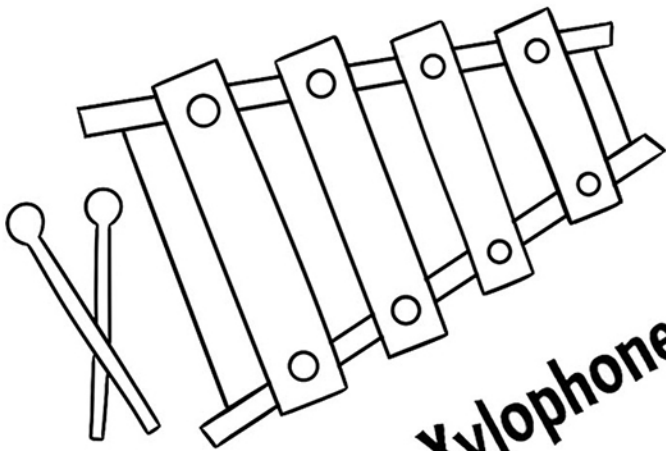

Xylophone

X-ray

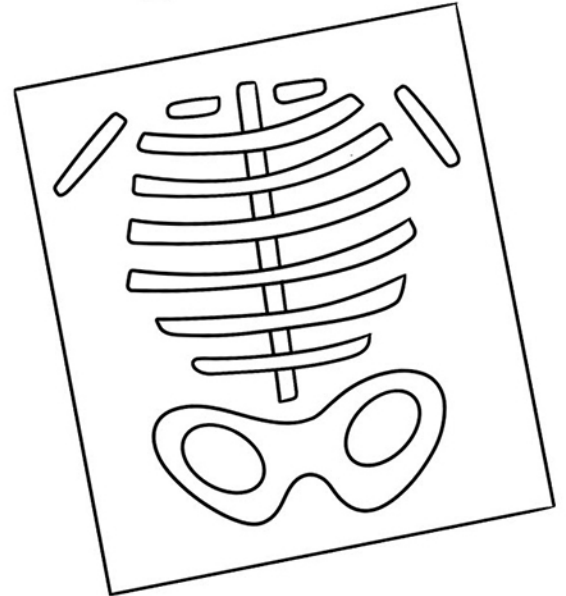

Xerox

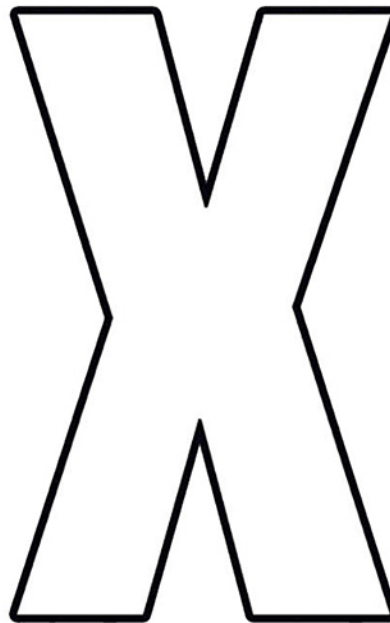
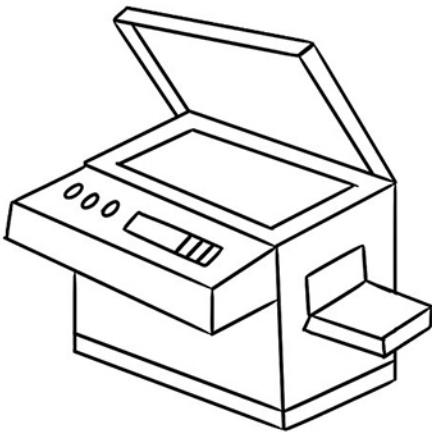

**X's and O's
in tic-tac-toe**

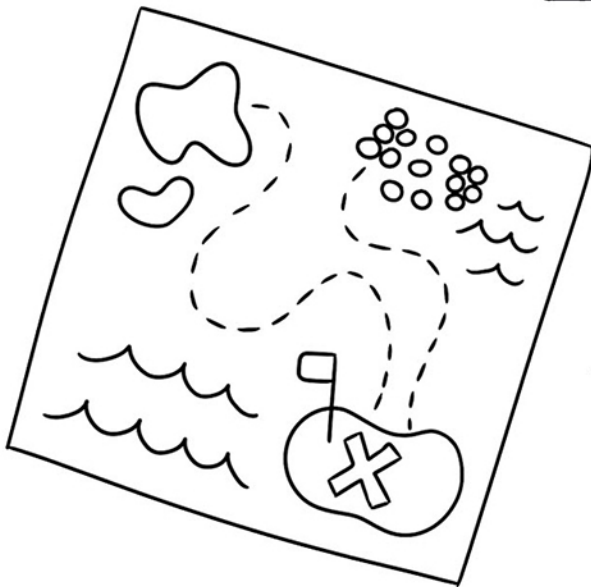

**X marks the
spot!**

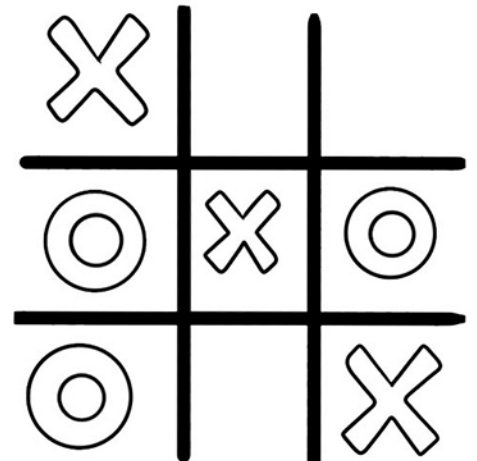

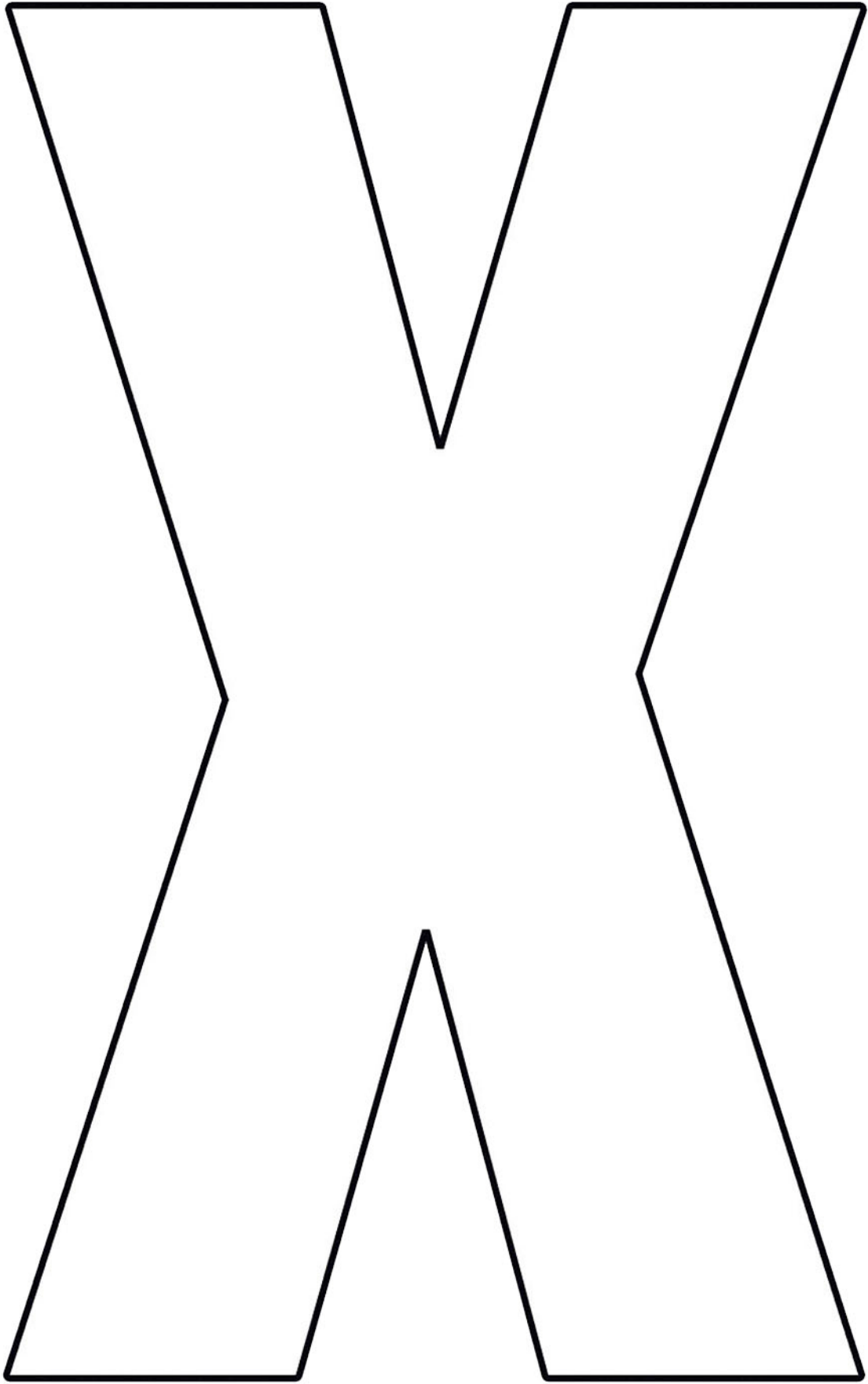

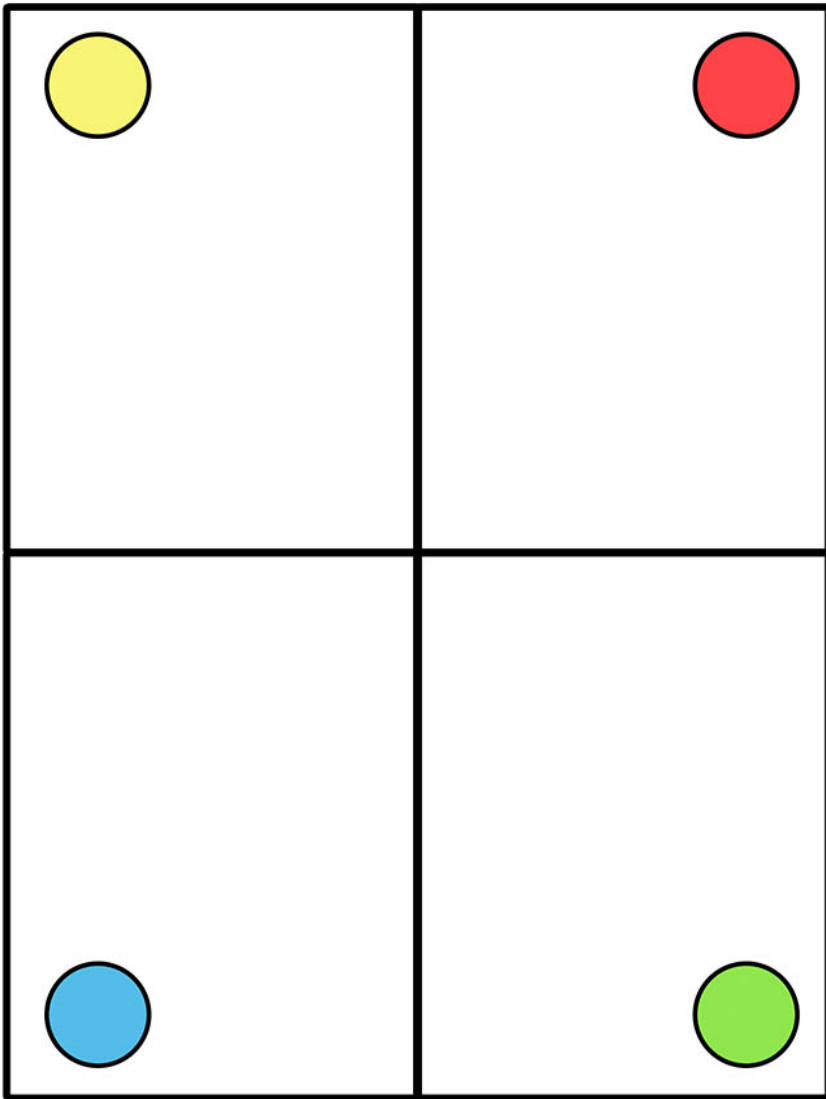

**What letter do
you see?**

Name:

Date:

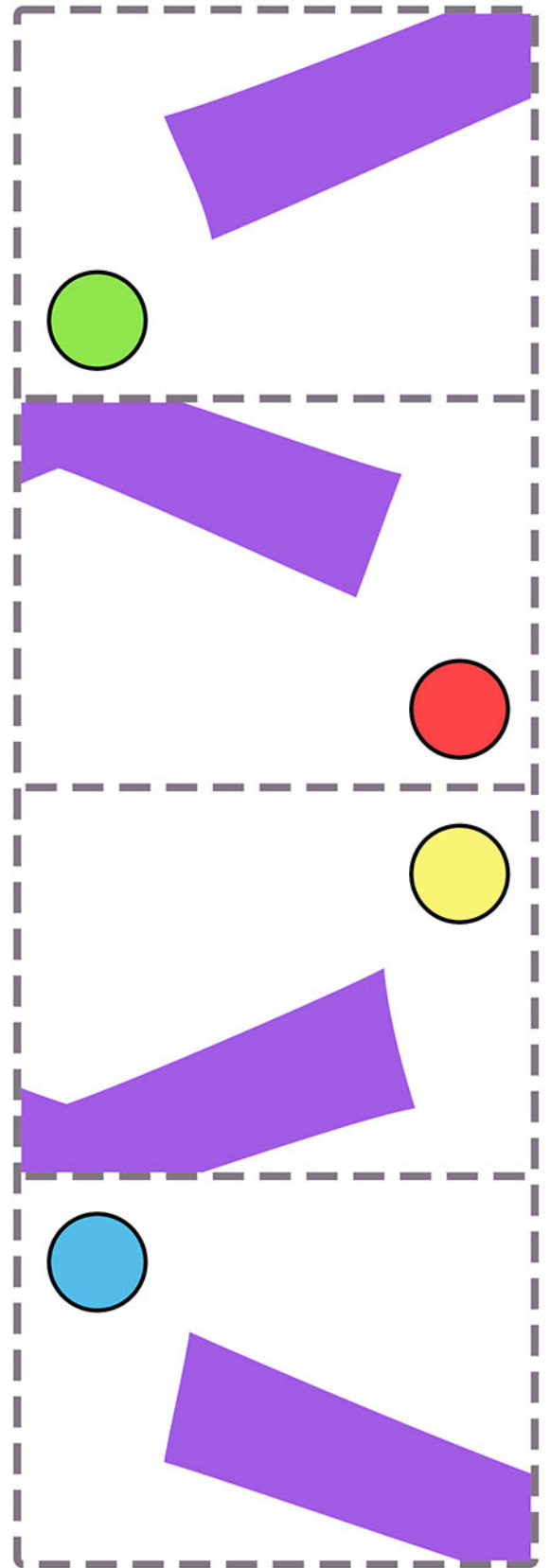

**Cut out the pieces above
and glue each one to its
matching circle of color.**

Name:

Date:

Trace the missing letter X.

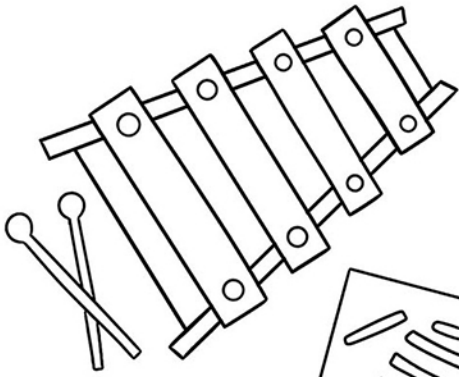

 X ylophone

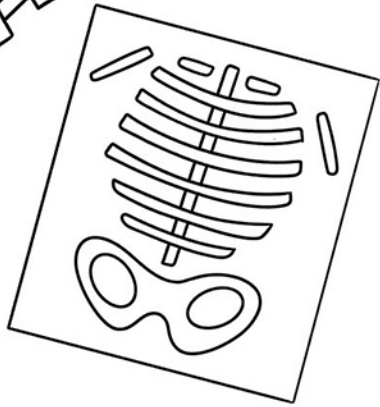

 X -ray

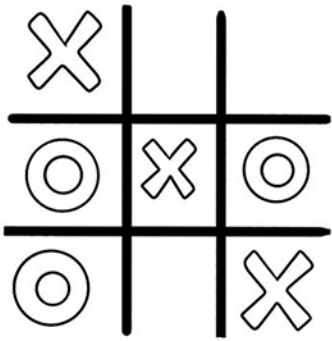

 X 's and O's

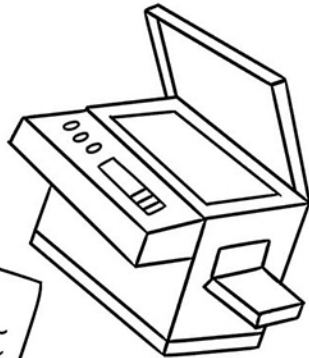

 Xerox

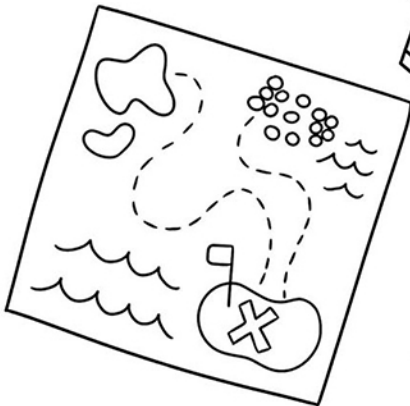

 X marks the spot!

Name:

Date:

Letter X

Trace, color, find.

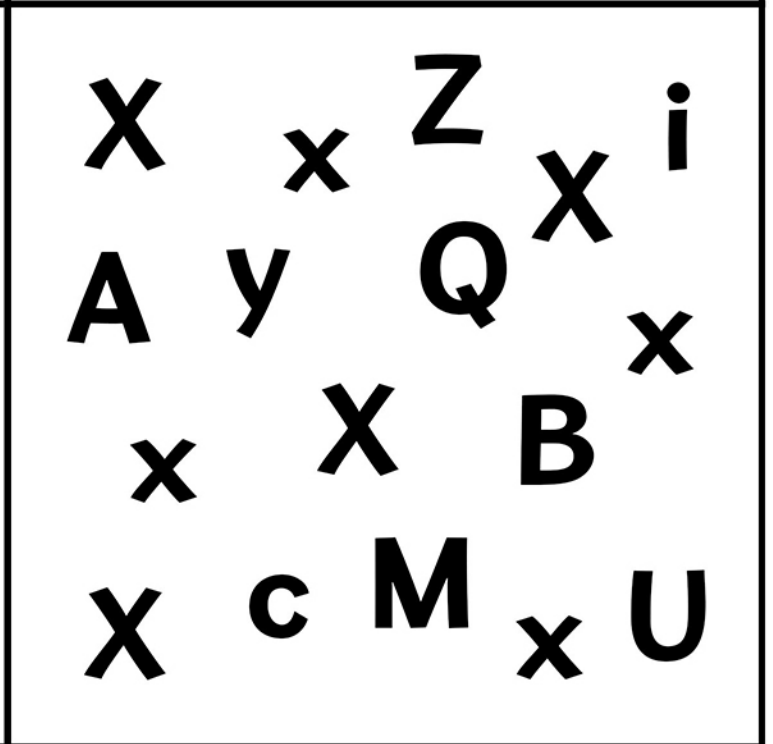
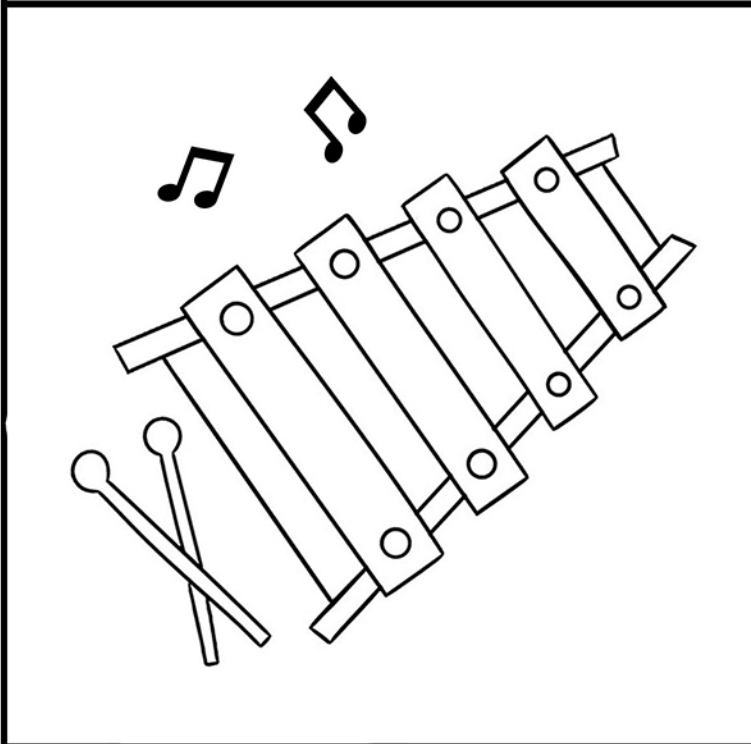
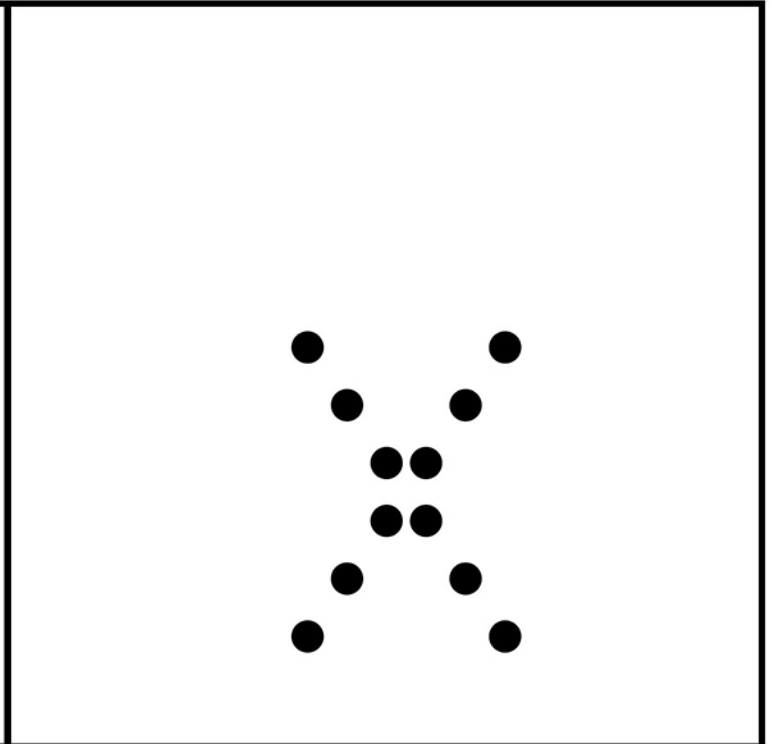
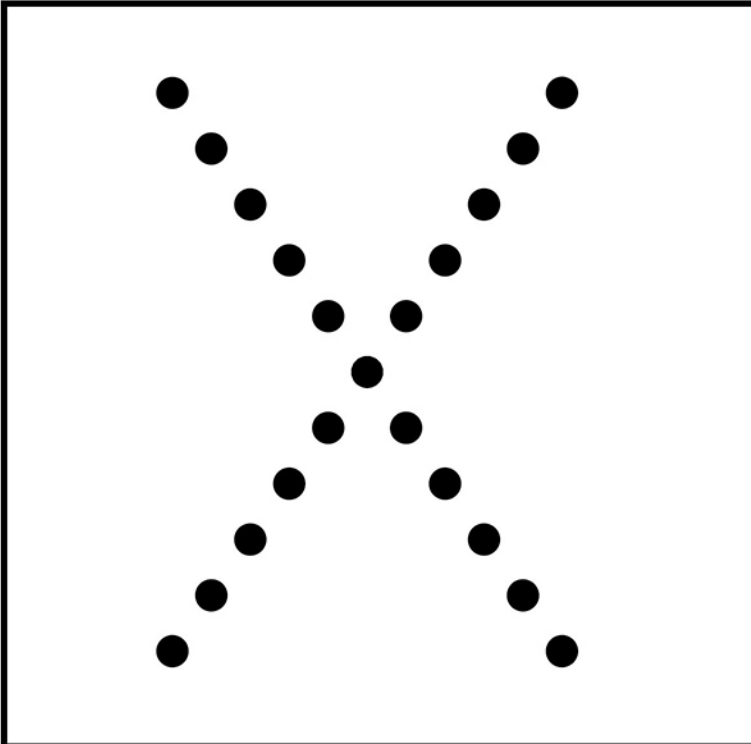

Name:

Date:

Letter X Sort

Cut on the dotted lines and glue each letter into its matching column.

X

uppercase

x

lowercase

X

x

x

X

x

x

X

X

x

X

Name:

Date:

X is for X-Ray!

Put one dot into each circle with the letter X.

A collection of 40 circles, each containing a letter. The letters are: P, X, A, U, X, X, N, C, E, X, B, Z, X, K, D, K, V, O, R, X, M, T, Z, X, W, X, S, K, X, Z, X, G, H.

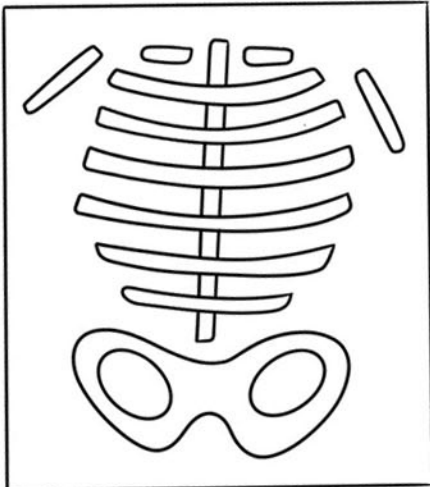

X is for Xylophone!

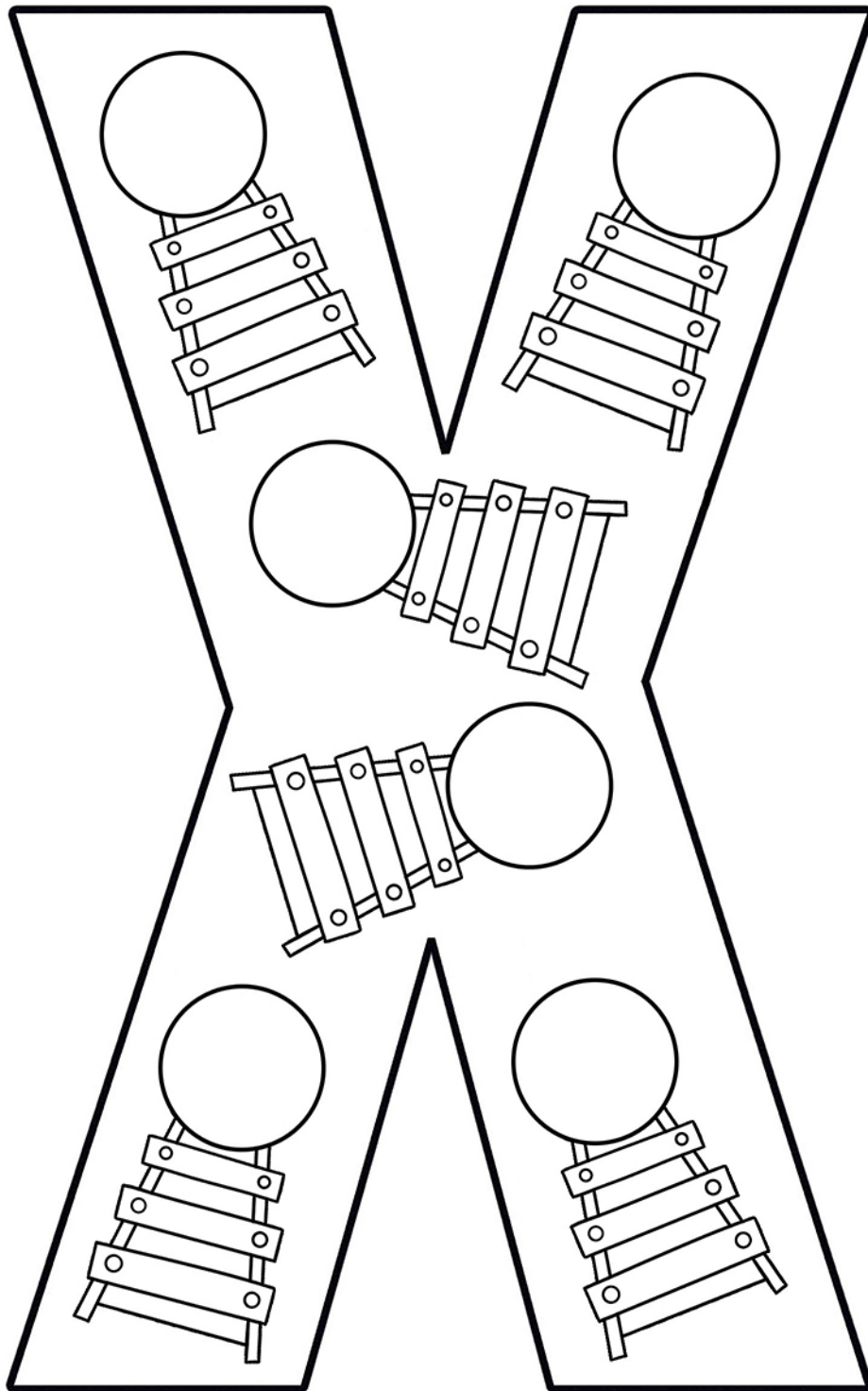

X is for Xylophone!

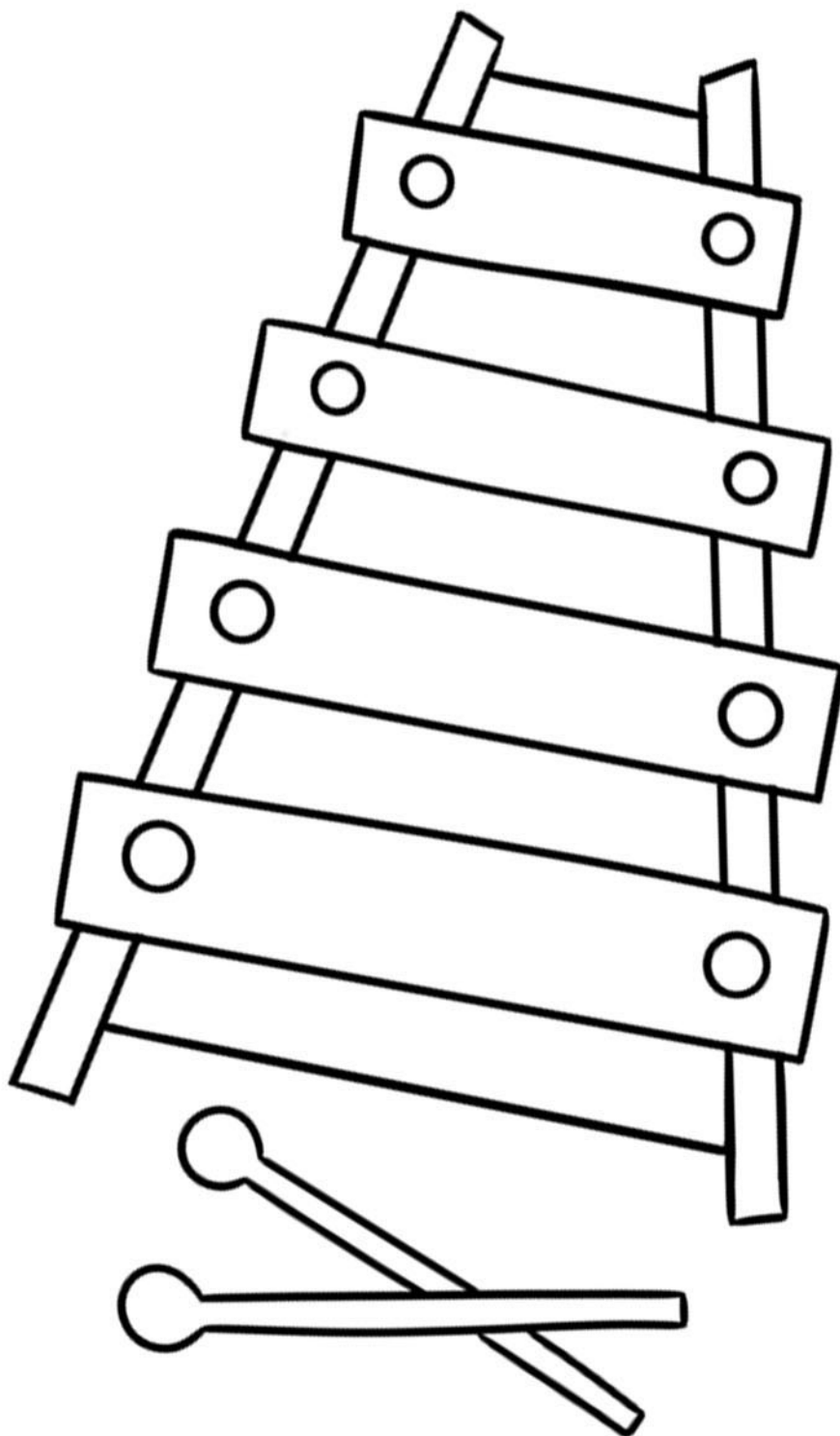

Name:

Date:

X x

